

Article number: 201058307
Description: E+G Handwheel
GN 949-140-K16-D

Measures

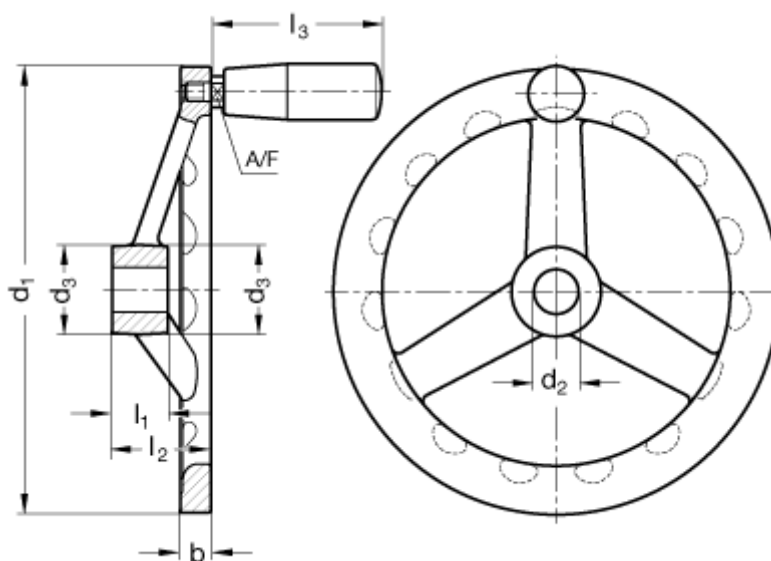

A/F	= 11	l3	= 71
b	= 10	Number of spokes	= 3
d1	= 140		
d2	= 16		
d3	= 28		
Handle diameter	= 23		
l1	= 18		
l2	= 30,5		